

DTF R

150-EM

Ø150mmx220mm(Ø5.91"x8.66")

Plastic Duct



Iron Duct



HOUSING	(1)PP (Polypropylene) material anti-acid and alkali (2)Thickened stainless steel with ultraviolet-proof
IMPELLER	Centrifugal Flow Type, ABS Plastic
BEARING	Ball
MOTOR TYPE	Single Phase Ball Bearing Motor
TERMINATION	Lead Wire
OPERATING VOLTAGE RAGE	220VAC to 240 VAC for 230V Type
DIELECTRIC STRENGTH	1,500 VAC for 1 second
INSULATION	Class F
INSULATION RESISTANCE	10M Ohms Min. @ 500VDC
OPERATING TEMPERATURE	-20°C to + 60°C
SAFETY	Thermally Protected
ROHS COMPLIANCE	Yes
IP LEVEL	IP44

150mm

SPECIFICATION

MODEL NO.	RATED VOLTAGE(V)	RATED CURRENT(A)	INPUT POWER(W)	SPEED (RPM)	MAX. AIR PRESSURE		MAX. AIR FLOW		NOISE dB(A) @1M
					inchH2O	mmH2O	CFM	m3/min	
DTFR150V2-EM	220	0.64	120	2500	1.61	40.79	217.89	6.17	52

DIMENSION

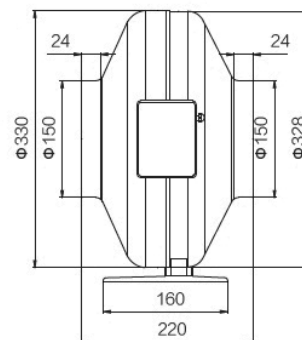
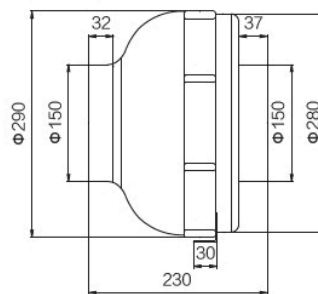
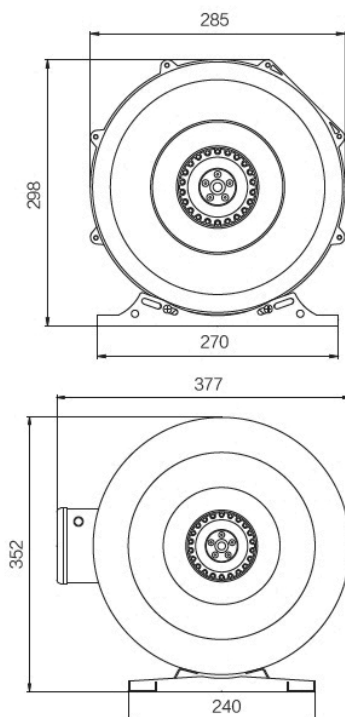

Unit : mm

SYMBANG

AIR PERFORMANCE

